

DATASHEET

Lotti

SRF3W077 • flexiiANT®

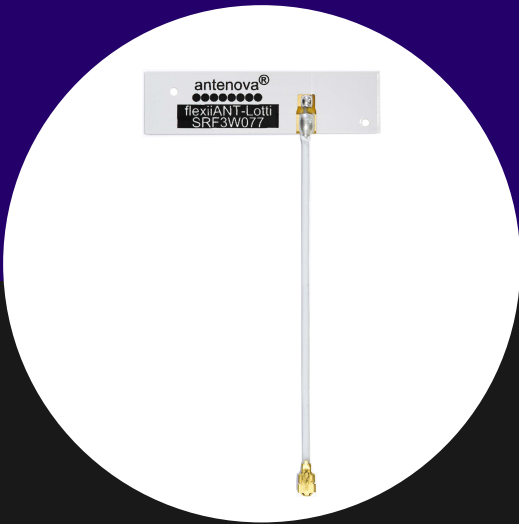

Features

- Antenna for the 2.4–2.5GHz, 4.9–5.9GHz and 5.925–7.125GHz Wi-Fi6E & WiFi7 bands
- 802.11a/b/g/j/n/ac/ax
- The new band for WiFi6E & WiFi7 (5.925–7.125GHz) provides 1200MHz extra bandwidth
- Maintains high performance within device: DFI (Designed For Integration)
- 1.13mm diameter RF cable with I-PEX MHF connector
- Self-Adhesive mounted
- Quick integration minimizes design cycle
- High performance
- 100mm cable – (other lengths available, MOQs apply)

Note: This product is compatible with Bluetooth® technology but does not incorporate Bluetooth® technology

1. Description

Lotti is intended for use with all Wi-Fi6E applications. A flexible PCB antenna with cable & connector enables a simple 'plug and play' connection to the host PCB. The antenna covers the Wi-Fi6E & WiFi7 bands: 2.4-2.5 GHz, 4.9-5.9GHz and 5.925-7.125GHz

2. Applications

- WiFi6E & WiFi7 Routers
- WiFi6E & WiFi7 surveillance cameras
- USB dongles for WiFi6E & WiFi7
- Game Consoles
- Set-Top Boxes
- Network Devices
- MIMO Systems

3. General data

Frequency	2400-2500MHz 4900-5900MHz 5925-7125MHz
Polarization	Linear
Operating temperature	-40°C to +85°C
Environmental condition test	ISO16750-4 5.1.1./5.1.2
Impedance with matching	50 Ω
Weight	<0.5g
Antenna type	FPC Self-adhesive 3M 468MP
Dimensions	30.0 x 8.0 x 0.15 (mm)

4. Part number

SRF3W077



5. RF characteristics

Frequency	2400-2500 MHz	4900-5900 MHz	5925-7125 MHz
Peak gain	2.8dBi	3.2dBi	4.4dBi
Average gain (Linear)	-1.5dB	-1.9dB	-1.7dB
Average efficiency	70%	65%	70%
Maximum return loss	-16dB	-12dB	-13dB
Maximum VSWR	1.3:1	1.6:1	1.5:1

All data measured on SRF3W077 in a loaded condition adhered to a 2mm thick ABS carrier.

Standard cable length for this antenna is 100mm.

6. RF performance

6.1. Return loss

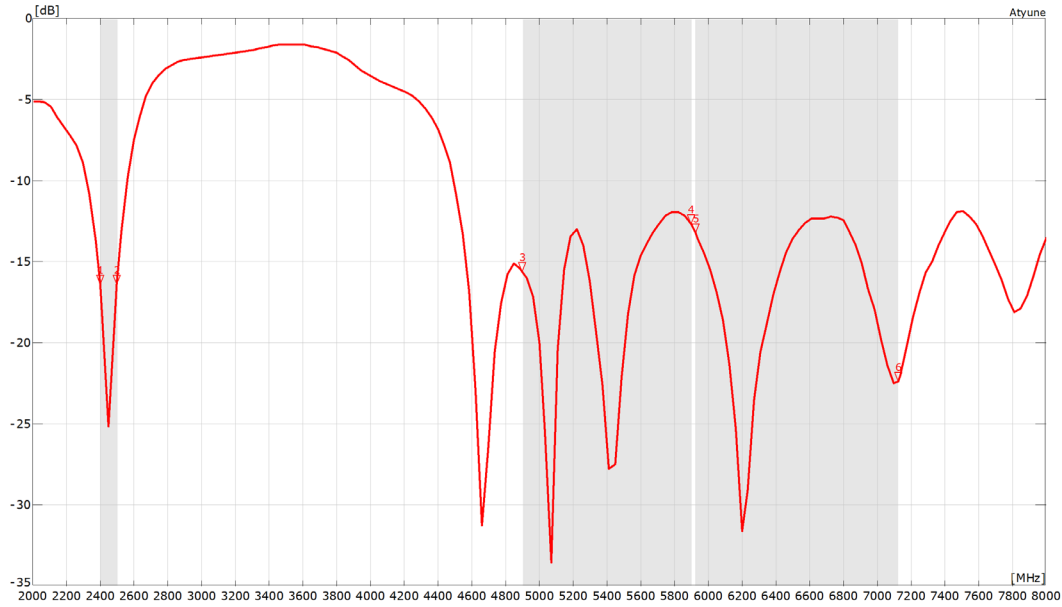

6.2. VSWR

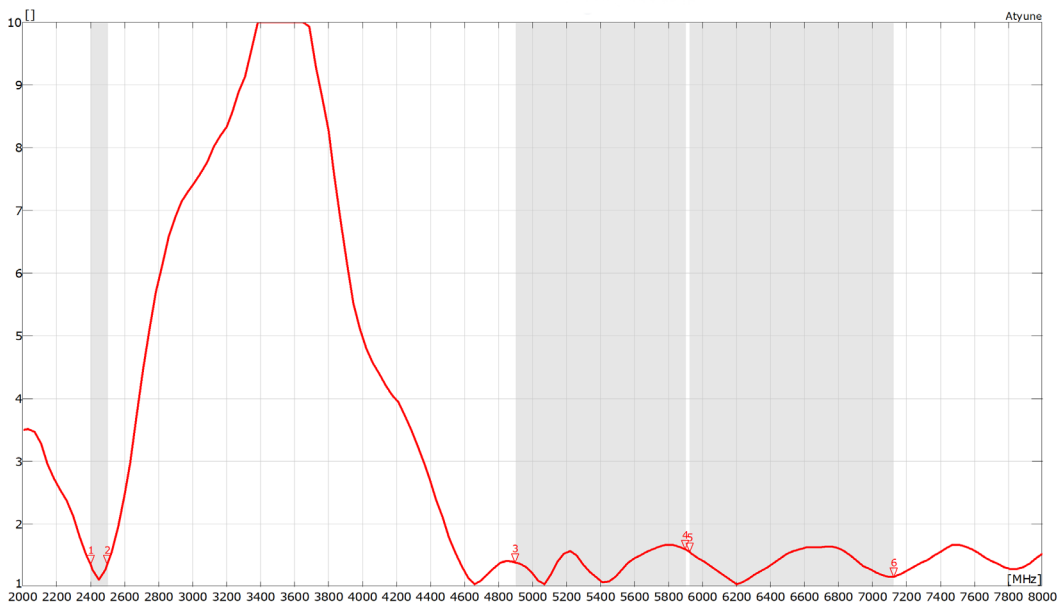

All data measured on SRF3W077 in a loaded condition adhered to a 2mm thick ABS carrier

Standard cable length for this antenna is 100mm

6.3. Efficiency

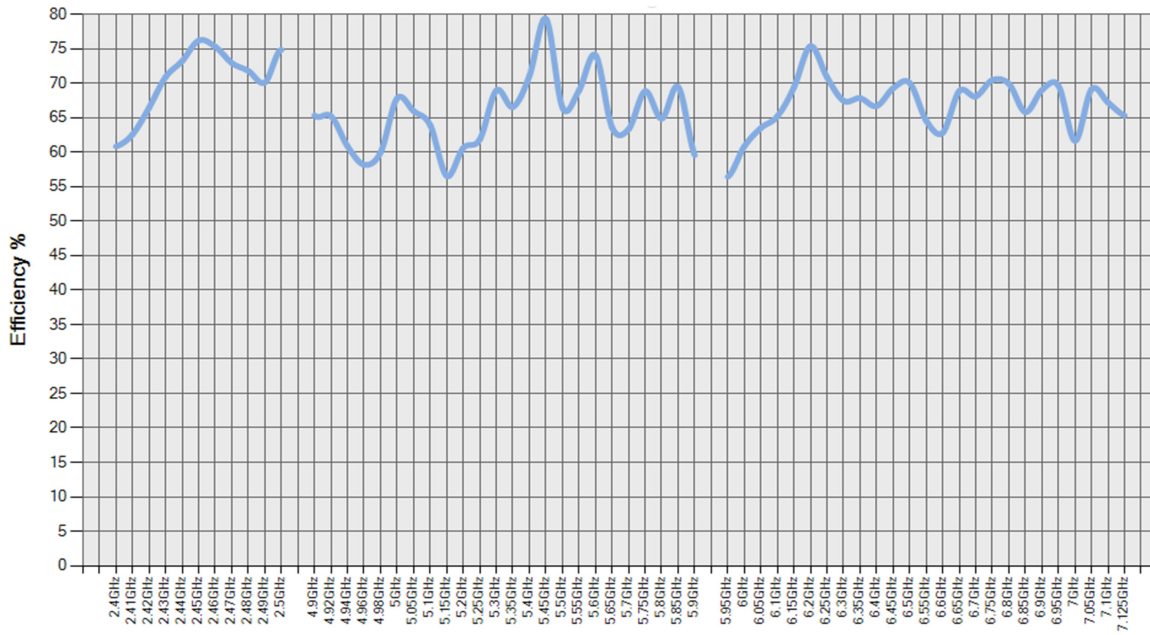

All data measured on SRF3W077 in a loaded condition adhered to a 2mm thick ABS carrier

Standard cable length for this antenna is 100mm

6.4. Antenna pattern

6.4.1. 2400 – 2500 MHz

3D pattern at 2450MHz

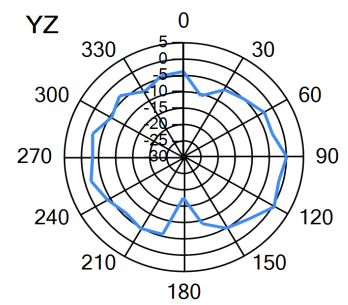
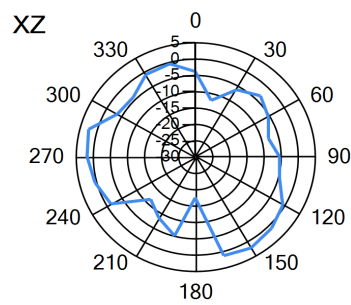
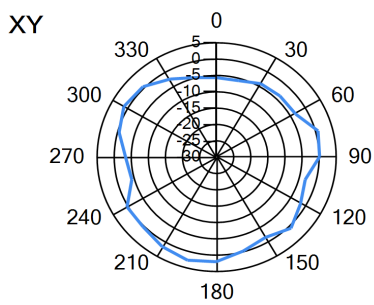
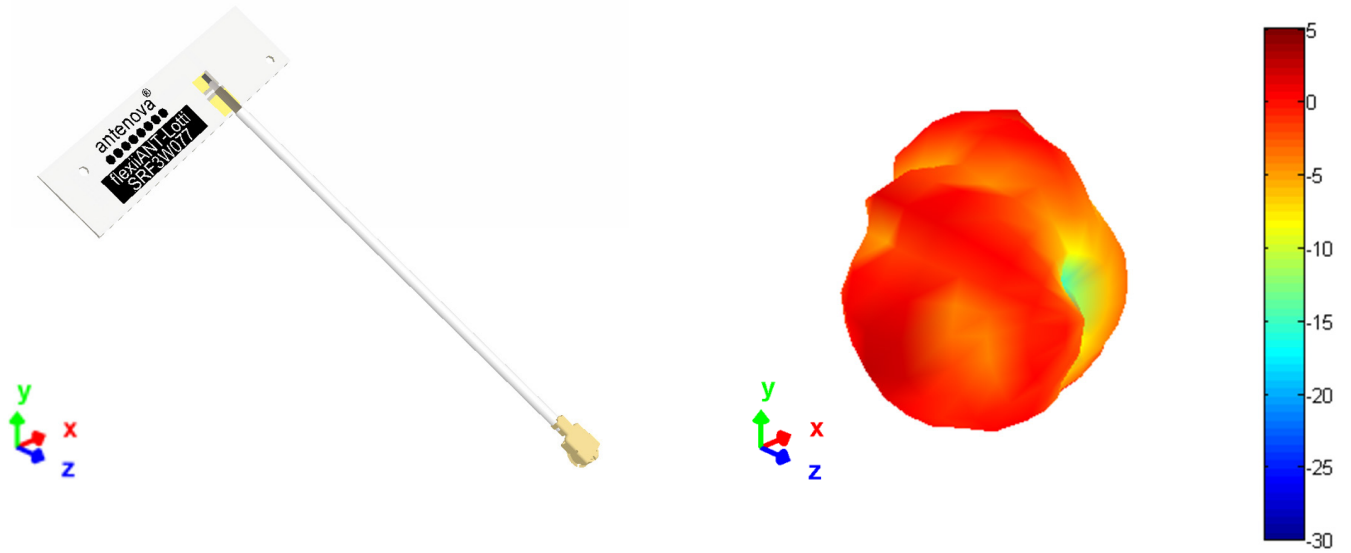

— 2.45GHz

6.4.2. 4900MHz-5900 MHz

3D pattern at 5500 MHz

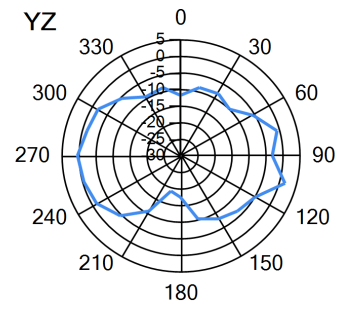
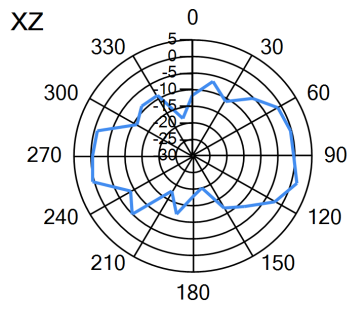
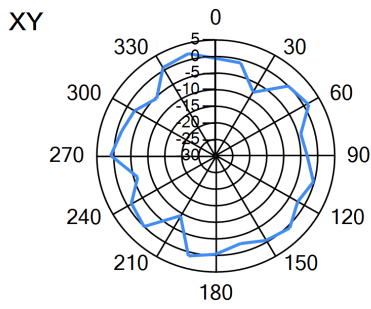
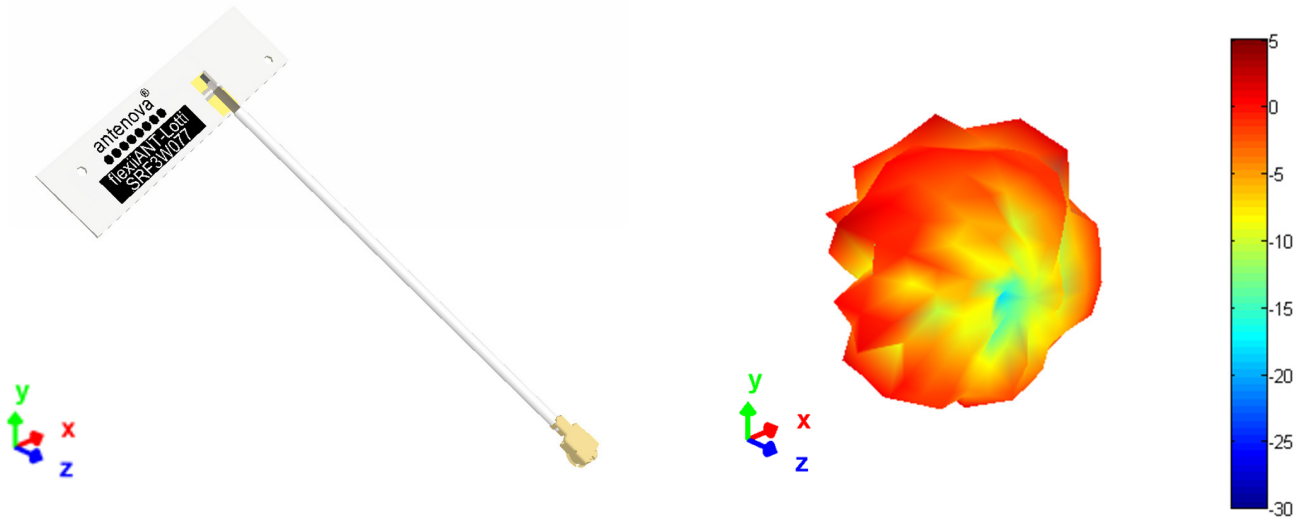

— 5.5GHz

6.4.3. 5925 MHz–7125 MHz

3D pattern at 6550 MHz

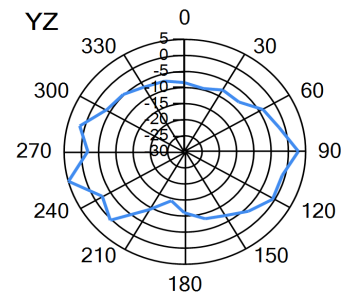
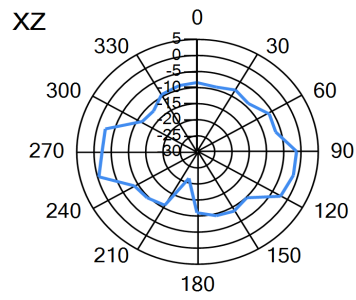
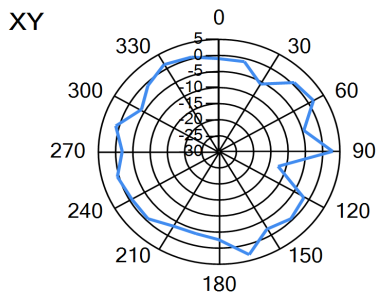
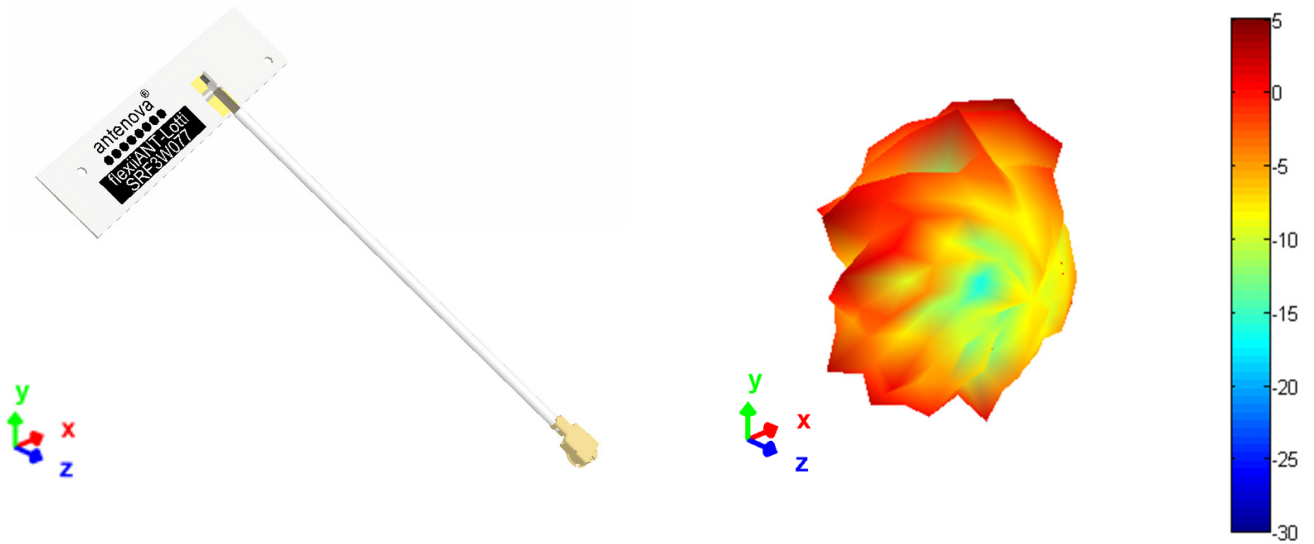

— 6.55GHz

7. Antenna dimensions

7.1. Dimensions FPC section

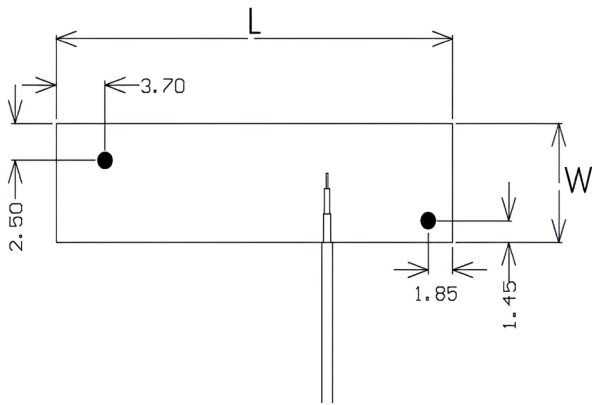

L	W	T
Length	Width	Thickness
30.0 ±0.1	8.0 ±0.1	0.15 (nominal)

All dimensions in (mm)

7.2. Dimensions assembled

SRF3W077-100
Length
103 ±2.0

All dimensions in (mm)
Standard cable length for this antenna is 100mm

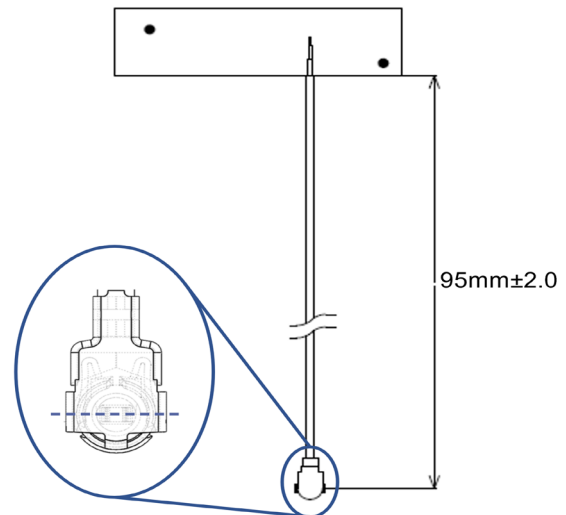

7.3. I-PEX connector MHF1 (20278-112R-13)

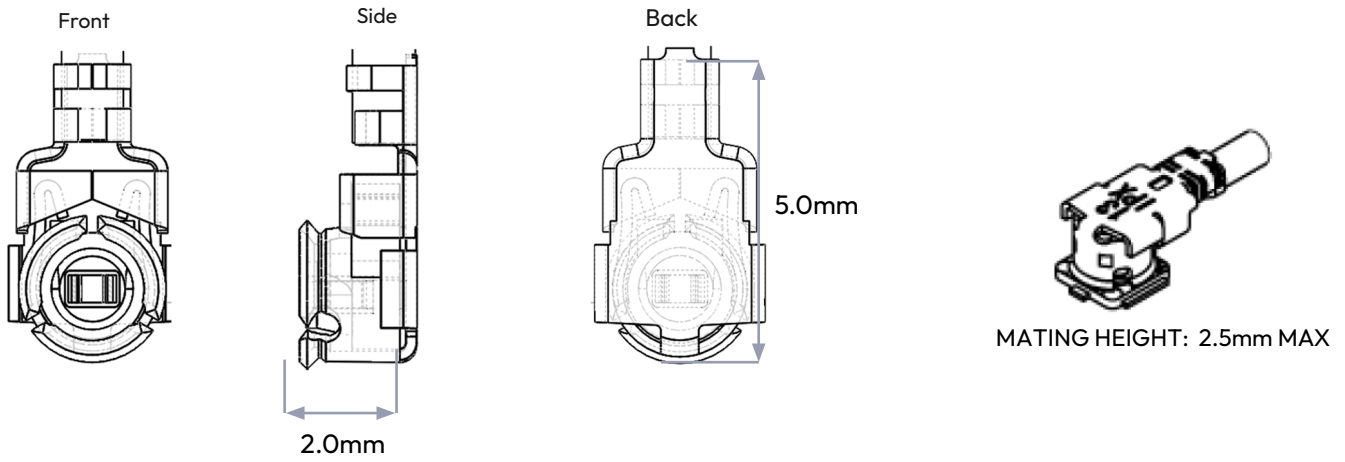

I-PEX	
Material	Copper alloy
Plating	Ag

All dimensions in (mm)

7.4. Assembly

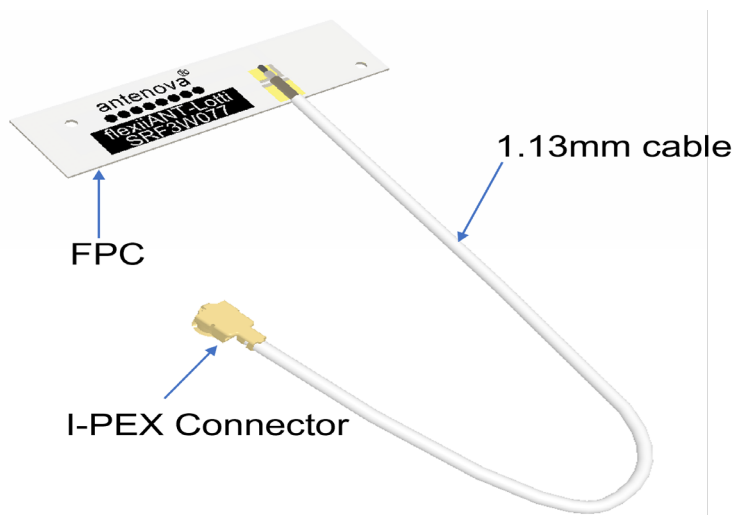

8. Electrical interface

8.1. Host interface

The host PCB requires the mating connector which is the I-PEX MHF (UFL) receptacle. The location should be close to the chip/modules pin for the RF. Any feed from this receptacle should be maintained at 50Ω impedance.

8.2. Transmission line

- Must have a characteristic impedance of 50Ω .
- Length should be kept to a minimum.
- It is recommended to design a co-planar waveguide, you can use the [Transmission line calculator](#) on [Antenova.com](#) to calculate the dimensions for your requirements
- Should have DC blocking capacitor (e.g. 220pF) placed in line to protect the RF front end.

9. Mechanical fixing

The antenna uses 3M 468MP adhesive on the reverse side of the FPC. The antenna has an easy access split line to peel off to reveal the adhesive side. It is designed for a one time fix to a clean smooth surface. The antenna is keyed with two 1mm locating holes for easy positioning.

FPC back side

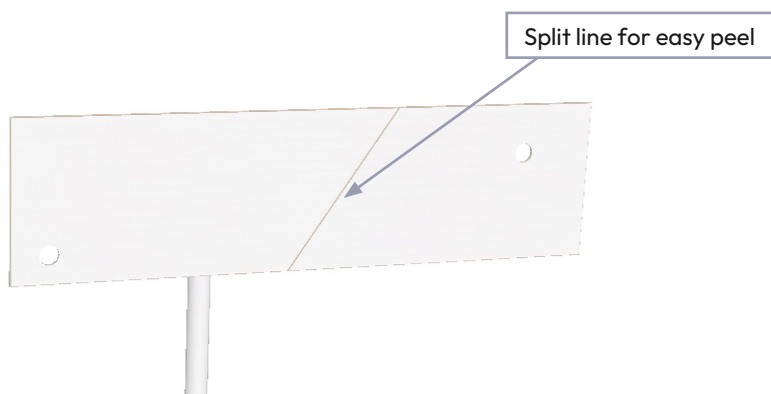

10. Antenna integration guide

We recommend the following during the design phase to maximise antenna performance and minimize noise:

- Minimum 4 layer PCB
- Route signals and power internally where possible
- Flood all layers with ground
- Knit ground on all layers together with plenty of vias

Follow placement guidance carefully, in addition Antenova provide technical support to help you through all stages of your design. Register for an account on <https://ask.antenova.com/> to access technical support.

10.1. Antenna placement

For FPC antennas the host PCB size is not critical to performance, however consideration must be given to placement. Using six spatial directions, as shown below, the antenna should ideally maintain a minimum of three directions free from obstruction in order to radiate effectively. Where there are obstructions (e.g. PCB, metal parts, battery etc.) a minimum clearance should still be maintained. These minimum clearances are described later in this section.

Six spatial directions relative to FPC

Example with 5 spatial directions clear

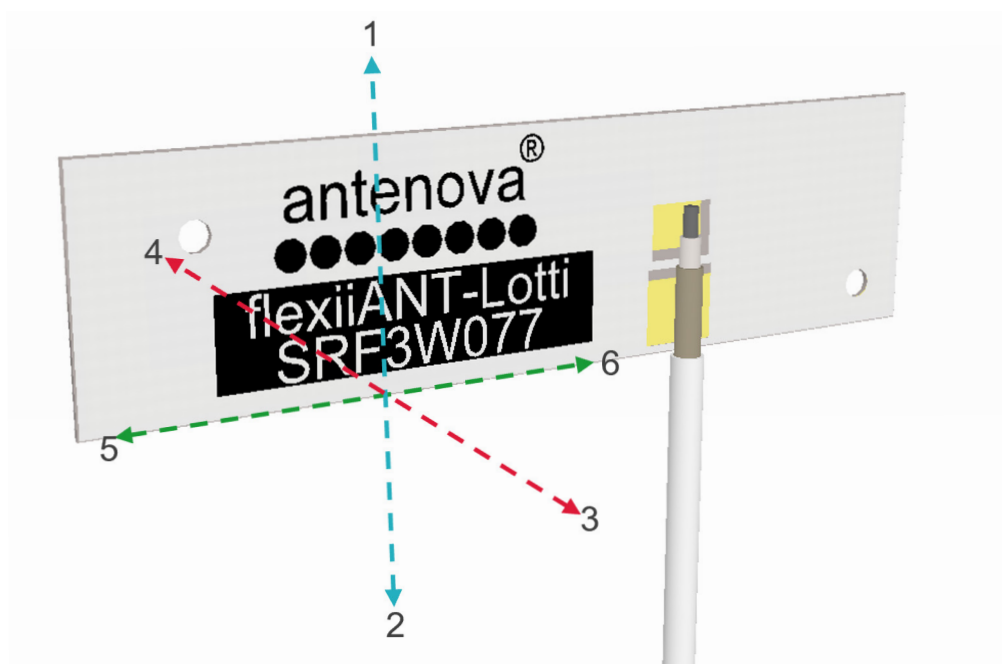

10.2. Orientation of FPC

The orientation of the FPC with respect to the host PCB should be defined depending on the unit. The proximity of the GND will have an influence on the antenna so the PCB location relative to the antenna should be considered.

The FPC will normally be placed in one of the three following options for orientation. In each option a distance (d) is the critical dimension to consider.

The diagram below shows the minimum value of (d) for each. Other obstructions may increase this dimension.

Vertical mounted

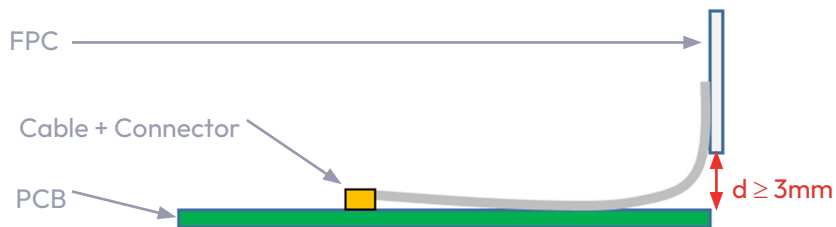

Co-planar to PCB

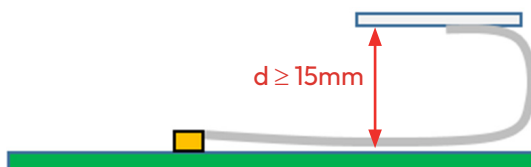

Planar to PCB (Same plane)



11. Hazardous material regulation conformance

The antenna has been tested to conform to RoHS and REACH requirements. A certificate of conformance is available from Antenova's website.

12. Packaging

The antennas are stored within a plastic bag of 100 pcs.

100 units per bag (Labelled)

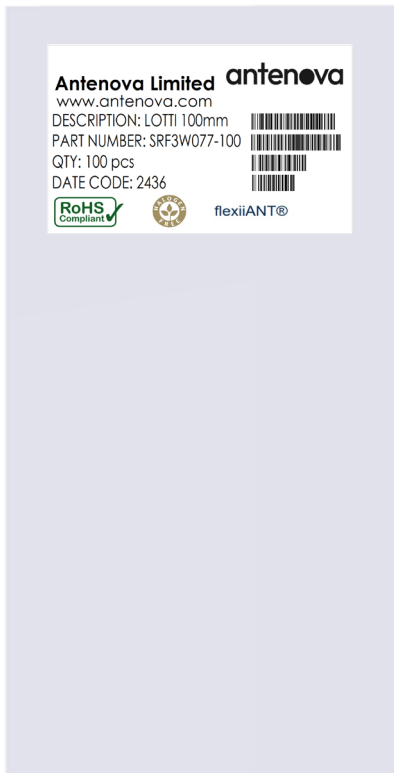

12.1. Optimal storage conditions

Temperature	-10°C to 40°C
Humidity	Less than 75% RH
Shelf life	18 Months
Storage place	Away from corrosive gas and direct sunlight
Packaging	Antennas should be stored in unopened sealed manufacturer’s plastic packaging.

Note: The shelf life of the antenna is 18 months, provided the bag of 100 pieces remains factory- sealed.

12.2. Label information



Quality statements

Antenova’s products conform to REACH and RoHS legislation. For our statements regarding these and other quality standards, please see antenova.com.

Antenova reserves all rights to the contents of this document. Antenova gives no warranties based solely on the accuracy or completeness of the contents of this document and reserves the right to make changes to the specifications of the products described herein at any time and without notice.



Datasheet version

3.01 released 28th Oct 2025

Antenna design, integration and test resources

Product designers – the details contained in this datasheet will help you to complete your embedded antenna design. Please follow our technical advice carefully to obtain optimum antenna performance.

We aim to support our customers to create high performance wireless products. You will find a wealth of design resources, calculators and case studies to aid your design on our website.

Antenova's design laboratories are equipped with the latest antenna design tools and test chambers. We provide antenna design, test and technical integration services to help you complete your design and obtain the required certifications.

If you cannot find the antenna you require in our product range, please contact us to discuss creating a custom antenna to meet your exact requirements.

Share knowledge with RF Experts around the world

ask.antenova is a global forum for
designers and engineers working with
wireless technology

[Visit Ask.Antenova](#)

Visit antenova.com

**Order antenna samples and
evaluation boards, and read our
antenna resources**

Visit antenova.com

Request a volume quotation for antennas:

[**sales@antenova.com**](mailto:sales@antenova.com)

+ 44 (0) 23 9400 1023

Global headquarters

**Antenova Ltd, 7 The Briars,
Waterberry Drive, Waterlooville,
Hampshire, PO7 7YH**